

Products > Aperture Wafers > A30.00

Aperture Wafers - A30.00

Specifications

Model	A30.00
Inside Diameter	.0196/.0198"
Outside Diameter	.0865/.0875"
Thickness	.0245/.0255"
Radius	.025/.035"
ID Length	.0037/.0041"



Description

Aperture Wafers are precision controlled orifices where the ID Length is controlled very tightly.

Typical Applications

- Hematology Instrumentation
- Ink Jet Printing
- Flow Control

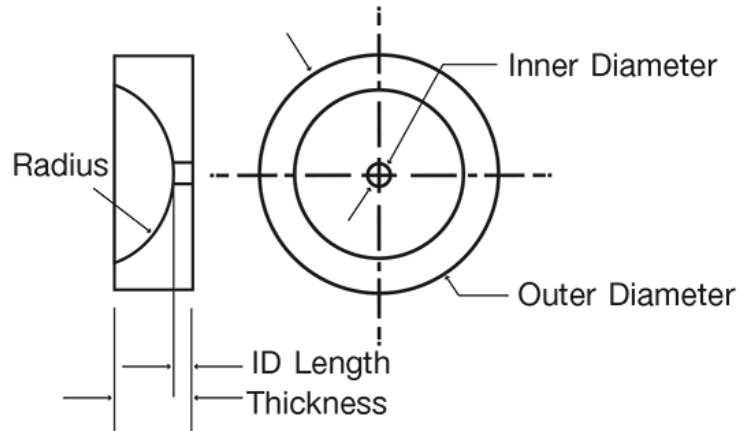

NOT SEEING EXACTLY WHAT YOU NEED?

We specialize in creating a wide range of custom optical components and custom mechanical components including a variety of shapes - from internal holes and tapers to outer flanges, angles and surface finishes. Contact us and we will consult with you to create a custom component that meets all of your specifications.